

# Wynncom W262 User Manual

**Note:** The content of the manual is correct when it is released, but “**Wynn Telecom Limited**” reserves the right to modify the technical specification without additional notification. Some content in the manual may be different from the mobile phone, as the accessory software, SIM card or service varies by providers

## Table of Contents

<b>IMPORTANT SAFETY PRECAUTIONS</b> .....	3
<b>INTRODUCTION</b> .....	10
<b>1. PHONE DISPLAY</b> .....	10
<b>GETTING STARTED</b> .....	12
<b>TEXT ENTRY</b> .....	14
<b>1. INPUT METHOD</b> .....	14
➤ <i>Changing the input modes</i> .....	15
➤ <i>Entering Symbols</i> .....	15
<b>3. MULTI TAPS INPUT</b> .....	15
<b>4. NUMERIC INPUT</b> .....	15
<b>CALLING</b> .....	15
<b>1. MAKING A CALL</b> .....	15
<b>2. ANSWERING A CALL</b> .....	16
<b>OVERVIEW OF MENU FUNCTIONS</b> .....	17
<b>MENU FUNCTIONS</b> .....	19
<b>HOW TO USE</b> .....	19
<b>1. MESSAGES</b> .....	19
<b>2. PHONEBOOK</b> .....	21
<b>3. CALL CENTER</b> .....	22
<b>4 SETTINGS</b> .....	23
<b>5. Y ZONE</b> .....	27
<b>6. MULTIMEDIA</b> .....	27
<b>7. MULTIMEDIA</b> .....	28
<b>8. FILE MANAGER</b> .....	31
<b>9. ORGANIZER</b> .....	31
<b>10. ORGANIZER</b> .....	34



### ***Important safety precautions***

This section contains important information on the safe and efficient operation of your mobile device.

For your safety, please refer to the guideline prior to using the phone.

Note: Failure to comply with the following precautions may be dangerous or illegal.

#### **Drive safely at all times**

Do not use a hand-held phone while driving. Park the vehicle first.

#### **Switch off the phone when refueling**

Do not use the phone at a refueling point (service station) or near fuels or chemicals.

#### **Switch off in an aircraft**

Wireless phones can cause interference. Using them in an aircraft is both illegal and dangerous.

#### **Switch off the phone near all medical equipment**

Hospitals or health care facilities may be using equipment that could be sensitive to external radio frequency energy. Follow any regulations or rules in force.

#### **Interference**

All wireless phones may be subject to interference, which could affect their performance.

#### **Be aware of special regulations**

Meet any special regulations in force in any area and always switch off

your phone whenever it is forbidden to use it, or when it may cause interference or danger.

### **Water resistance**

Your phone is not water-resistant. Keep it dry.

### **Sensible use**

Use only in the normal position (held to the ear). Avoid unnecessary contact with the antenna when the phone is switched on.

### **Keep your phone away from small children**

Keep the phone and all its parts, including accessories, out of the reach of small children.

### **Accessories and batteries**

Use only approved batteries and accessories, such as headsets and PC data cables. Use of any unauthorized accessories could damage you and your phone and may be dangerous.

If jewelry, keys, beaded chains, or other conductive materials touch exposed battery terminals, this could complete an electrical circuit (short circuit), become very hot, and could cause damage or injury. Be careful when handling a charged battery, particularly when placing it inside a pocket, purse, or other container with metal objects.

- ❖ Never use a charger or battery that is damaged in any way.
- ❖ Use the battery only for its intended purpose.
- ❖ If you use the phone near the network's base station, it uses less power. Talk and standby time are greatly affected by the signal strength on the cellular network and the parameters set by the network operator.
- ❖ Battery charging time depends on the remaining battery charge, the type of battery, and the charger used. The battery can be charged and discharged hundreds of times, but it will gradually wear out. When the operation time is noticeably shorter than normal, it is time to buy a new

battery.

- ❖ If left unused, a fully charged battery will discharge itself over time.
- ❖ Use only approved batteries, and recharges your battery only approved chargers. Disconnect the charger from the power source when it is not in use. Do not leave the battery connected to a charger for more than a week, since overcharging may shorten its life.
- ❖ Extreme temperatures will affect the charging capacity of your battery: it may require cooling or warming first.
- ❖ Do not leave the battery in hot or cold places because the capacity and lifetime of the battery will be reduced. Try to keep the battery at room temperature. A phone with a hot or cold battery may not work temporarily, even when the battery is fully charged.
- ❖ Do not short-circuit the battery. Accidental short-circuiting can occur when a metallic object like a coin, clip or pen causes a direct connection between the + and – terminals of the battery (metal strips on the battery). For example, do not carry a spare battery in a pocket or bag where the battery may contact metal objects. Short-circuiting the terminals may damage the battery or the object causing the short-circuiting.
- ❖ Dispose of used batteries in accordance with local regulations. Always recycle. Do not dispose of batteries in a fire.
- ❖ To ensure while using the phone please do not get the battery charge.
- ❖ During the course of charging, it is normal to find the battery and the phone slightly heat-up. The Phone will automatically protect itself when battery temperature rises so as to control temperature variation.

**Note:** This phone is just charged 50%. Please use up the power and recharge it fully. This is the case with the second recharge. After three repetition, the battery can achieve it' s best performance condition.

## **Operating Environment**

Remember to follow any special regulations in force in the area you are in, and always switch off your phone whenever it is forbidden to use it, or when it may cause interference or danger. When connecting the phone or any accessory to another device, read its user's guide for detailed safety instructions. Do not connect incompatible products.

As with other mobile radio transmitting equipment, users are advised that for the satisfactory operation of the equipment and for the safety of personnel, it is recommended that the equipment should only be used in the normal operating position (held to your ear with the antenna pointing over your shoulder).

Extreme heat or cold, Avoid temperatures below -10°C/14°F or above 45°C/113°F

## **Electronic devices**

Most modern electronic equipment is shielded from radio frequency (RF) signals. However, certain electronic equipment may not be shielded against the RF signals from your wireless phone. Consult the manufacturer to discuss alternatives.

## **Pacemakers**

Pacemaker manufacturers recommend that a minimum distance of 15 cm (6 inches) be maintained between a wireless phone and a pacemaker to avoid potential interference with the pacemaker. These recommendations are consistent with the independent research and recommendations of Wireless Technology Research. If you have any reason to suspect that interference is taking place, switch you're your phone immediately.

## **Hearing aids**

Some digital wireless phones may interfere with some hearing aids. In the event of such interference, you may wish to consult your hearing aid manufacturer to discuss alternatives.

## **SIM AT Service**

SIM Card provides several value-added services.

These functions will only display and work on the menu of the phone when your SIM card is supported. The content and the terms of the function lists will depend on your network service provider.

Please contact your network service provider (a network operator or the service provider) in regards with availability of any services related to the SIM card, application information and the costs.

## **Other medical devices**

If you use any other personal medical devices, consult the manufacturer of your device to determine if it is adequately shielded from external RF energy. Your physician may be able to assist you in obtaining this information. Switch off your phone in health care facilities when regulations posted in these areas instruct you to do so.

## **Vehicles**

RF signals may affect improperly installed or inadequately shielded electronic systems in motor vehicles. Check with the manufacturer or its representative regarding your vehicle. You should also consult the manufacturer of any equipment that has been added to your vehicle.

## **Posted facilities**

Switch off your phone in any facility where posted notices require you to do so.

## **Potentially explosive environments**

Switch off your phone when in any area with a potentially explosive atmosphere, and obey all signs and instructions. Sparks in such areas

could cause an explosion or fire resulting in bodily injury or even death. Users are advised to switch off the phone while at a refueling point (service station). Users are reminded of the need to observe restrictions on the use of radio equipment in fuel depots (fuel storage and distribution areas), chemical plants, or where blasting operations are in progress. Areas with a potentially explosive atmosphere are often but not always clearly marked. They include the areas below decks on boats, chemical transfer or storage facilities, vehicles using liquefied petroleum gas, such as propane or butane, areas where the air contains chemicals or particles, such as grain, dust or metal powders, and any other area where you would normally be advised to turn off your vehicle engine.

### **Emergency calls**

This phone, like any wireless phone, operates using radio signals, wireless, and landline networks as well as user-programmed functions, which cannot guarantee connection in all conditions. Therefore, you should never rely solely on any wireless phone for essential communications like medical emergencies. To make or receive calls, the phone must be switched on and in a service area with adequate signal strength. Emergency calls may not be possible on all wireless phone networks or when certain network services and/or phone features are in use. Check with local service providers.

To make an emergency call: **(For India example: 112,911,100,101,102)**

1. Key in the emergency number for your present location. Emergency numbers may vary by location.
2. Press the Send Key.
3. Inform your location. Do not end the call until given permission to do so. Certain features like Call Barring may need to be deactivated before you can make an emergency call. Consult this document and your local cellular service provider.



## Other important safety information

- ❖ Only qualified personnel should service the phone or install the phone in a vehicle. Faulty installation or service may be dangerous and may invalidate any warranty applicable to the device.
- ❖ Check regularly that all wireless phone equipment in your vehicle is mounted and operating properly.
- ❖ Do not store or carry flammable liquids, gases, or explosive materials in the same compartment as the phone, its parts, or accessories.
- ❖ For vehicles equipped with an air bag, remember that an air bag inflates with great force. Do not place objects, including installed or portable wireless equipment, in the area over the air bag or in the air bag deployment area. Improperly installed wireless equipment could result in serious injury if the air bag inflates.
- ❖ Switch off your phone before boarding an aircraft. It is dangerous and illegal to use wireless phones in an aircraft because they can interfere with the operation of the aircraft.
- ❖ Failure to observe these instructions may lead to the suspension or denial of telephone services to the offender, or legal action, or both.

## Wynncom Authorized Care Centre

Only qualified service personnel may repair your phone.

It is highly recommended to have a repair service by qualified service personnel. Use only the approved accessories and batteries.

**Note:** Please use the original components in order to achieve the best use of effects, as the use of non-original components may cause damage to the machinery, in such case company shall not be responsible.

# Introduction

## 1. Phone Display









Key	Function
Dial/receive key	Dial and receive calls via SIM1/SIM2 card. View SIM1/SIM2 call history in idle mode.
Call End Key/power on/off key	Pressing and holding to turn the phone on/off. End a call or reject an incoming call. Return to the idle mode.
Left Soft Key	Enter Shortcuts
Right Soft Key	Access the phonebook list in idle mode. Return to the previous menu.
OK Key	Enter the Main menu in idle mode.
*	Press and hold to toggle between *, +, (pause character) P, and (wait character) W. Press to enter symbol when editing text.
#	Press to switch input modes when entering text. Press and hold to activate silent mode/Second time Long press for bring the phone to Vibrator mode/third

	time Long press Idle mode.
Navigation Key	Press to access four functions in idle mode (Up: Audio Player Down:Camera Left: Write Messages Right: Profiles Within a menu, press Up, Down, Left or Right to scroll through menu options.

**Note:** “Press” in this manual, means to press and release the key; “press and hold” means to press and hold the key for at least 3 seconds.

## 2. Icons & Symbols

The Icon shown on the display may vary depending on your country or service provider. The number 1 and 2 in icons mean SIM1 and SIM2.

Status	Icons
1.SIGNAL STRENGTH	
2.SILENT MODE	
3.VIBRATE MODE	
4.BATTERY STATUS	
5.INDOOR MODE	
6.OUTDOOR MODE	
7.EARPHONE	



# Getting Started

Please read the safety instructions in the "Safety Information and Notices" section before use.

## 1. Inserting the SIM Card and the battery

### Remove the back cover

Make sure the phone is switched off. You need to remove the back cover of your phone before you can insert the SIM card. Hold the phone with the front facing downwards lift the cover upwards to remove it. For further clarification, refer to the image below :

### Remove the battery

Put your finger on the black holder located at the bottom of the battery slot and lift the battery up to remove it.

### Insert the SIM card

Make sure that the clipped corner of the SIM card is facing the correct direction (clipped corner at top left) and the metallic contacts are facing downwards. Slide the SIM card into the card slot until it stops. For further clarification, refer to the image below :

## **Install the battery**

With the metallic contacts of the battery facing the metallic contacts in the battery slot, press the battery down until it locks into place.

## **2. Inserting a Micro SD (External Memory) Card**

Slide the Micro SD card into the Micro SD card slot with the metallic pins facing downwards. For further clarification , refer to the image below :

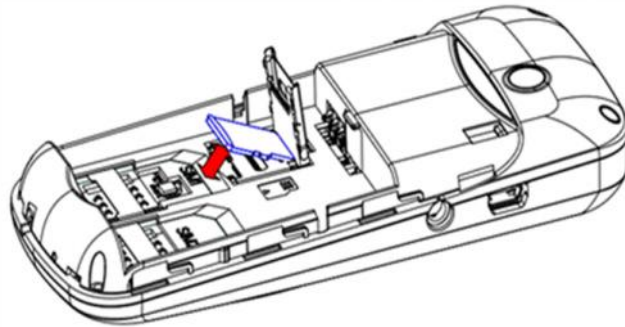

## **3. Turning the phone on**

To turn the phone on, press and hold the Call End key. If you have already enabled the Sim Lock function then enter the PIN code (the 4 to 8 digit code of your SIM card). It is preconfigured and provided to you by your network operator or retailer. If you enter an incorrect PIN code 3 times in succession, your SIM card will be locked. To unlock it, you must obtain the PUK code from your network operator and if you enter an incorrect PUK code 10times in succession ,your need to change the SIM card.

## **4. Charging the Battery**

Ensure the battery is inserted in the handset. To charge the battery, plug in the charger connector at the bottom of your phone (USB interface) and then plug the other end into an AC power socket.

The battery symbol indicates the charging status. While charging, the charge indicators will scroll. When all the scroll bars are steady, the battery is fully charged. It takes about 4 hours to fully charge the battery.

Disconnect the charger from the phone.

Disconnect the charger from the AC power socket.

**Note:** If the battery is powerless, the battery icon will reappear after a few minutes of charging.

## 5. Important Password

Phone lock password is set as 0000 by default.

## 6. Keypad Lock and Unlock

Go to Settings > Security > Auto keypad lock to select the time for keypad lock.

In idle mode, if the time expires, the keypad will be locked automatically.

Press the Left Soft Key and then \* Key in quick succession to lock/unlock the keypad manually.

## 7. Transfer files to the Micro SD (External Memory) card

Insert your Micro SD card into a card reader, and then connect the card reader to the USB port of a PC. The PC will auto detect the card reader as a removable disk. You can access the Micro SD card memory now.

Download or upload the files to Micro SD card.

Finally, insert your Micro SD card into your cellular phone, you can view the files in Menu > File Manager > Memory card.

# *Text Entry*

## 1. Input Method

Your cellular phone supports several input methods, which include:

Multitap (ABC / abc / Abc)

Numeric (123)

Insert Symbol

## Hindi Input

### ➤ Changing the input modes

During text editing, you can press the # Key to switch input modes, or press the Left Soft Key [Options] and choose Input method to select different input modes.

### ➤ Entering Symbols

In any input mode, press the \* Key to open the symbols input screen. Use the navigation key to choose the desired symbol and the OK key to select it.

## 3. Multi taps Input

This method requires multiple key presses to reach the desired character: the letter "h" is the second letter on the 4 key, so you must press 4 twice quickly to enter "h". Using this mode requires you to press a key as many times as needed to enter the desired letter.

Example:

To enter the word "home" in Multitap input mode "abc", press key 4(GHI) twice, press key 6(MNO) thrice, press key 6(MNO) once and key 3(DEF) twice.

## 4. Numeric Input

Press the # Key to select "123" input option then you can enter the numbers.

# ***Calling***

## 1. Making a Call

In idle mode, enter the phone number. Press the dial key to call the number from SIM1 and SIM2. Press the Call End Key to end the call.

**Note:** During a call, press the navigation up and down key to adjust the volume. You can press the Left Soft Key [Options] to choose Sound Recorder to record.

In most countries, recording telephone conversations is subject to legislation. We advise you to notify the caller if you intend to record your conversation and only do so if they agree.

### **Making an International Call**

1. Press the \* Key twice quickly to enter "+".
2. Enter the country code.
3. Enter the area code (normally without the 0 before it) followed by the phone number.
4. Press the Dial Key to call directly.

### **2. Answering a Call**

Press the call receive key/Dial Key to answer calls. Press the Call End key to reject it.



# ***Overview of menu functions***

To access Menu mode, press [**Menu**] in Idle mode.

\* Some menus are operator-, network- and subscription-dependent

## **1. Messages**

- 1.1 Write Message
- 1.2 Inbox
- 1.3 Outbox
- 1.4 Drafts
- 1.3 Sentbox
- 1.4 Schedule SMS
- 1.5 Message Blacklist

## **2. Phonebook**

## **3. Call Center**

- 3.1 Dialed Numbers
- 3.2 Received Calls
- 3.3 Missed Calls
- 3.4 Rejected Calls

## **4. Settings**

- 4.1 Call
- 4.2 Phone
- 4.3 Display
- 4.4 Security

## **5. Y Zone**

- 5.1 Hungama Radio
- 5.2 Smart Auto Call Record
- 5.3 Games
- 5.4 STK

## **6. Multimedia**

- 6.1 Camera
- 6.2 Video Recorder
- 6.3 Image Viewer
- 6.4 Audio Player

6.5 Video Player

6.6 FM Radio

6.7 Sound Recorder

7. **Profile**

8. **File Manager**

9. **Organizer**

# Menu Functions

## How to Use

### Select Menu

Press the Left Soft Key [Menu] to enter main menu in idle mode.

Press the Navigation Key to choose desired operation and press the Left Soft Key [Ok] to enter the selected operation.

You can exit a menu and return to idle mode by pressing the Right Soft Key [Back] or the Call End Key.

### Main Menu

Messages	Phonebook	Call Center
Settings	Y-Zone	Multimedia
Profiles	File Manager	Organizer

For further clarification, refer to the picture below:

## 1. Messages

### 1.1 Write Message

You can write new message by using this function. When you input the message to be sent, press left soft key to send, to insert the templates, to add contact person information and symbol, and to save, etc.

**-Send:** Enter the interface of input number, you can dial the phone number directly, or press left soft key to enter the Phonebook and choose the number to send.

- Insert the templates:** Enter the templates interface and you could insert the template to the message.
- Add Contact Info:** Enter the Phonebook interface and you could insert the Phonebook information to the message.
- Add Phiz:** Enter the symbol interface and add the symbols to the message.
- Save:** Save this message to the drafts.
- **Schedule SMS:** Set the message for Schedule SMS.

## 1.2 Inbox

You can store the SMS. The icons before the message list means whether this message is SMS and which is stored in SIM1, SIM2 or the phone.

Choose one SMS and press left soft key, then you will do several operations, for example, reply the SMS, delete, Call, Lock and mark. Press OK key directly you can read this SMS.

**Reply:** You could choose to reply by SMS.

**Delete:** Delete this message.

**Forward:** Forward the message to any number.

**Dial:** Call the addresser.

– – **Lock/unlock:** Lock the message or unlock it.

**Mark:** Choose this message or all messages in the inbox, or only choose the messages saved in SIM 1 or SIM 2.

**Operate:** To Copy or move the messages from SIM to Phone memory and vice-versa.

**Sort:** Sort the messages in the inbox by time, Name, Subject or message type.

--**Delete Repeated Numbers:** You can delete the messages from the same number.

---**Add To Blacklist** – To add the number to the blacklist, to restrict the messages from certain number .

## 1.3 outbox

You can store the SMS you've sent in failure. The SMS could be differentiated by different icons. The two icons before the message list means whether this message is SMS ,and it is stored in SIM1, SIM2 or the phone.

Choose one SMS and press left soft key, you could send, delete, lock, mark, sort, and so on.

– – **Send:** Send this SMS .

– – **Delete:** Delete this message.

– – **Lock/unlock:** Lock the message or unlock it.

**Mark:** Choose this message or all messages in the inbox, or only choose the messages saved in SIM 1 or SIM 2.

**Sort:** Sort the messages in the inbox by time, contact person, subject or message type.

## 1.4 Draft box

You can store the SMS you've edited. The SMS could be differentiated by different icons. The two icons before the message list means whether this message is SMS, and it is stored in SIM1, SIM2 or the phone.

Choose one SMS and press left soft key, you could delete, edit, lock, mark, sort, and so on.

- – **Delete:** Delete this message.
- – **Edit:** Edit this message.
- – **Lock/unlock:** Lock the message or unlock it.

**Mark:** Choose this message or all messages in the inbox, or only choose the messages saved in SIM 1 or SIM 2.

**Sort:** Sort the messages in the inbox by time, contact person, subject or message type.

## 1.5 Sentbox

You can store the SMS you've sent successfully. The SMS could be differentiated by different icons. The two icons before the message list means whether this message is SMS, and it is stored in SIM1, SIM2 or the phone.

Choose one SMS and press left soft key, you could delete, forward, lock, mark, sort, and so on.

- Delete:** Delete this SMS.
- Forward:** Forward this message to others.
- – **Lock/unlock:** Lock the message or unlock it.

**Mark:** Choose this message or all messages in the inbox, or only choose the messages saved in SIM 1 or SIM 2.

**Sort:** Sort the messages in the inbox by time, contact person, subject or message type.

## 1.6 Schedule SMS

You can Schedule SMS for specified date and time.

## 1.7 Blacklist

Add the number to the blacklist to avoid the messages.

## 2. Phonebook

This function could help you browse the Phonebook, store, edit and delete the names and phone numbers in the phone and SIM card. To facilitate the management of the records, this phone sets the group function, collecting the similar items into a group. The storage capacity of the SIM card varies.

On the standby interface, press right soft key to enter the interface of the Phonebook. When the record of the Phonebook is not empty, press left soft key for the following operation

The Options are as follows:

1. New- Add New Contact to Phone/SIM1/SIM2.
2. Edit – To edit the contact name and number.

3. Search: Search Contact.
4. Write SMS: You Can Write SMS/.
5. Call – To dial call directly on selected number.
6. Send vCard: Send vCard by SMS/Bluetooth
7. Delete – To delete the selected number.
8. Mark – To Mark Selected number/Mark all number.
9. Copy to-To Copy the number to SIM1/SIM2, Phone, Copy to Memory Card.
10. Copy All - You can Copy all Contact SIM1 to Card.
  - You can copy all contact SIM2 to Card.
  - You can copy all contact Card to phone.
11. Others:
  - Speed Dial Settings: You can edit at 3 to 9 numeric key.
  - Caller ID: You can set it On/off.
  - Memory Status: You can check the memory status of SIM1/SIM2

and Phone.

-Single Line Display: You can set the display mode of record list as one line or two lines.

## 3. Call Center

Display your recent call log.

### 3.1 Dialed Numbers

Display the list of your recent dialed numbers.

On the interface of Dialed, choose one dialed number, then press left soft key “Option” to enter the Option interface and you can get the following operations.

- **Details:** You can enquire the details of the record, including the name, number, date, time, calling time, etc.
- **Call:** Call on that number directly.
- **Save:** You can save this number into the SIM card or certain group in the phone.
- **Send SMS:** You can send SMS or to this number.
- **Add to existing contact:** Add this number to the existing record of the Phonebook.
- **Add to Blacklist:** Add this number to the blacklist.
- **Delete:** Delete this record.
- **Delete all:** Delete all the records in the Dialed list.

### 3.2 Received Calls

Display the list of your recent answered numbers. The operation is the same as

the Dialed.

### 3.3 Missed Calls

Display the list of your recent missed numbers. The operation is the same as the Dialed.

### 3.4 Rejected Calls

Display the incoming call records in the blacklist. The operation is the same as the Dialed.

## 4 Settings

You can customize the settings, such as time and date, language, call settings etc.

### 4.1 Call

#### 4.1.1 Dual SIM Settings

**Standby Mode:** You can choose which SIM is to enable.

**Settings of SIM card I/II:** You can set as dialing number, SMS, , service, prompt Dial, reply from the same card when both cards in use. After setting default card, select dialing number, sending SMS or , connecting web page or reply from the same card will use the default SIM card. If you set as reminding selection, then whenever you do abovementioned work, you will be asked to choose SIM card.

**Setting SIM name:** You can set any name you like as the name of SIM card slot.

#### 4.1.2 Network Settings

When your phone enjoys roaming service, the network can automatically or manually select network. The network roaming service can only be used when you subscribed the effective roaming service provided by the other network operator.

**Automatic selection:** Press left soft key, the phone will automatically search network. The operation will have the phone independently registered with the most proper network..

**Manual selection:** Press left soft key, the phone will search available network, and select the compatible network from the network list.

#### 4.1.3 Call Divert

When “call divert” function is started up, you can transfer the incoming call to voice inbox or other phone number according to the scheduled “call divert” conditions.

**Unconditional call divert:** All incoming calls will be transferred to voice inbox or other phone number according to the setup.

**If Busy:** When your number is busy, the incoming calls will be transferred to voice inbox or other phone number according to the setup.

**If no answer:** When there are missed calls in your phone, they will be

transferred to voice inbox or other phone number according to the setup.

**If Unreachable:** When your phone is power off or out of the service area, the incoming calls will be transferred to voice inbox or other phone number according to the setup.

**Cancel all calls divert:** You can delete all settings of call divert.

#### 4.1.4 Call Barred

All outgoing calls, incoming calls, roaming incoming calls, international outgoing calls, roaming international outgoing calls are available.

**All outgoing calls:** Start up the function will bar all outgoing calls.

**All incoming calls:** Start up the function will bar all incoming calls.

**Roaming incoming calls:** Start up the function will bar all roaming incoming calls.

**International outgoing calls:** Start up the function will bar all international outgoing calls.

**Roaming international incoming calls:** Start up the function will bar roaming international incoming calls.

**Cancel all call barring:** Cancel all restrictions on the call.

**Change password of call barring:** You can consult your network operator about the call barring password.

**Note: The above-mentioned function will need network support. To use the function, please contact your network service provider.**

#### 4.1.5 Call Waiting

You can turn on /off this function. When it is On, even when you are making a call, you can also receive another incoming call.

#### 4.1.6 Hide ID

The other side cannot see your phone number during the calling. This function must be supported by network.

#### 4.1.7 Select Line

Line Switch: Switch between line 1 and line 2. (Note: when line 2 is chosen, no calls can be made.)

#### 4.1.8 Flight Mode

You can start up the function directly or choose when power on. It is used in flight. When flight mode is working all the functions connect with network, such as SMS, dialing back, will be unavailable, to avoid interfering the signal of the flight you take.

#### 4.1.9 Others

-- **50 secs warning:** After connecting the call, if this option is On it warns for 50secs.

--**Connect Prompt:** When the function is started up, each time when a call is connected, the reminder sound can be heard.

**Answer/ Reject Mode:**



**Answer SMS to rejected call:** When an incoming call is rejected, a reminder “answer SMS” will appear.

**Automatic redial:** You can on/off this function. When it is on, a failed dialing will automatically redial.

## 4.2 Phone Settings

--**Time & Date:** You can set up the date and time on the phone as well as their display mode.

--**Select Language:** You can select phone language.

--**Input method settings:** Change the input method.

-- **Dedicated key Setting:** To set the dedicated key option as desired.

--**Auto Power on/off:** You can set the time and repeat mode of power-on and power-off.

--**Power management:** You can view the electric quantity of your battery.

--**Restore factory settings:** You can restore part of the phone settings as factory settings.

The default code of restoring factory settings is: 0000.

## 4.3 Display settings

- **Wallpaper settings:** You can set as default wallpaper image as well as more other wallpaper images.
- **Idle display settings:** You can set the information you require on idle display of you mobile phone.
- **Contrast:** On the screen backlight interface you can set different lightness of your phone by pressing the left/right direction key.
- **Backlight:** “Always on”, “30seconds”, “20seconds”, “15seconds”, “10seconds” and “5seconds” are available.
- **Keypad light:** “20seconds”, “10seconds”, “5seconds”, “nighttime mode” and “Deactivate” are available.
- **Animation Effect:** Set the Power on/off animation On/off.

## 4.4 Security

**PIN code:** You can on/off or modify PIN code. Correct PIN code shall be input when you unlock or off PIN code. If PIN code verification is started up, each time when you switch on your phone, you will have to input PIN code. If you have entered wrong PIN codes three times in a continuously, SIM card will be locked. You will have to get PUK code to unlock it. Please contact network operator to get PUK code when necessary.

**Note: The default PIN code is 0000.**

### **PIN2 code**

You can review PIN2 code. For details, please contact network operator.

### **Privacy Protection**

You can review privacy protection password. Besides, you can also set passwords for some menu ( call log,Message ,camera,contacts,My File,Ebook,Calender) .You have to enter password each time when you desire to open that particular Menu option where you have put password.

**Note: The default password of privacy protection mode is “0000”.**

**---Red Key Locks keypad:** By activating this function you can lock the keypad, just by selecting “Call end key”.

**Phone password:** You can on/off “phone password” or change it. When “phone password” is activated, you will have to enter “password” each time when you use the phone.

The default phone password is “0000”.

### **Mobile Tracker**

You can on/off this Mobile Tracker function or change anti password (the password shall be 6-digit).

When “Mobile Tracker” function is “on”, you can only use your SIM card. If different SIM card is used, the phone will automatically check it when you switch it on, and the phone will require you to input protection password. If the password is correct, you can set up the SIM card so that it is compatible with the Mobile Tracker function.

If you have entered wrong password for three time, when you switch on the phone, it will send warning SMS to your original SIM card every 24 hours If the

phone is switched off, the warning messages will be sent when you switch on the phone. The warning messages will indicate the existing SIM card and the neighborhood number. When 15 warning SMS were sent out, the phone cannot be used. You will have to take the purchase evidence and have to visit to Nearby Wynncom Service Center.

To guarantee the safety of your phone, you are suggested to start up the function when you purchased the phone.

- Activate: Activate Mobile tracker function.
- Deactivate: To Deactivate mobile Tracker function, you will have to enter the protection password you set for the phone.
- Change Password: To change protection password, you will have to input the protection password you set for the phone.

**The default Mobile Tracker password is “0000”.**

## 5. Y Zone

### 5.1 Hungama Radio

The hungama radio is IVR service to listen your favourite songs.

**Note:** Call charges as per operator plan shall appl.

### 5.2 Smart Auto Call Record:

You can on/off this function. When it is “on” all the incoming calls will record at the defined storage place.

**Note:** By default the storage is Call Record folder of memory card.

**When Smart Auto Call record is activated the file will save in the following format:**

**Name <Phone number<Date (YY-MM-DD)<Time ( Time will be in 24hr clock format)**

### 5.3 Game ( snake)

--New game: You can start a new push cases game.

Continue: You can continue to play the game you didn't finish last time.

Choose level: You can choose the level of the game.

### 5.4 STK

You can visit various SIM services, for instance, news, weather forecast and airlines etc. The services are specially designed for the device and are maintained by service provider.

## 6. Multimedia

### 6.1 Camera

You can take photo at any time and save the photo in memory card. The photo can be used as wallpaper of your device or you can send it to your friends through (multimedia messaging service).

#### ■ Digital Camera

You can view the photo on screen and press camera key to click a picture. On the photo preview interface (screen rotate), press left/right direction key to adjust focus; press up/down direction key to adjust menu settings; press OK key to get the picture; press down direction key to enter “take photo” menu: In camera interface press left soft key you can enter options menu as follows:

**Photo Directory:** You can enter camera list page to view the photos you shot.

#### **Settings:**

**Image quality:** There are three options in photo image quality: High, normal and Brief.

**Avoid Coruscate:** You can set as 50Hz or 60Hz.

**Sound of shutter:** You can set up the sound of shutter as: Activate or Deactivate.

**Auto save:** You can select Activate or Deactivate.

**Display Settings:** You can select Activate or Deactivate.

#### **Help:**

You can view the relevant operation instruction of the camera.

### 6.2 Video Recorder

The device is equipped with a video capture so that you can chat with your friends through it. A driver is needed to be installed when the video capture function is used. The details can be found in driver installation guide.

**Size:** You can set the photo image size.

**Brightness:** Six levels of brightness are available.

**Contrast:** Six levels of contrast are available.

**Effect:** The special effect can be classified into: normal, black and white, red, green, blue, yellow, canvas and negative.

In camera preview interface press left soft key you can enter options menu as follows:

**View video directory:** Enter into videos list.

#### **Settings:**

**Banding:** You can set as 50Hz or 60Hz.

**Audio:** You can set as on or off.

**Type:** You can set as 3gp

**Display parameters:** You can set as on or off

**Storage:** You can save it to the memory card.

#### **Help**





## 6.3 Image Viewer

You can view the pictures saved in the Memory Card as well as edit them freely.

In the picture list interface press left soft key you can do operations as follows:

- Change folder: Change the folder in which pictures are saved.
- Send: Send the pictures to others via or Bluetooth.
- Slide Play: Play the pictures in the list in a slide show manner.
- Delete: Delete the selected pictures.
- Set as wallpaper: Set the picture as standby wallpaper.
- Re-name: Rename the picture.
- Mark: Choose one or all of the pictures in the list.
- Details: View the details of the picture, including name, date, time and size.
- Slide settings: Set the play effect and delay time of the slide.

## 6.4 Audio Player

- This phone could play the MP3 stored in the Memory Card and support the background play.
- On the audio player interface, move cursor to the shortcut keys on the screen, you could rapidly operate the MP3 functions.
- Press  can play the MP3;
- Press  can make a pause;
- Press  can stop playing;
- Press  can choose the previous and next MP3.
- 
- Under the MP3 list interface, press left soft key, then you can do operations as follows:
  - --Open: Enter the Memory Card and open the MP3 stored in it.
  - --Current Play List: Display MP3 files list which are playing now.
  - --All Play list: Display all the MP3 or the play list you've saved.
  - --Set Call Ring: Set the selected MP3 as the ringtone of the incoming call.
  - --EQ Setting: Set the music style as general, classical, concert, jazz, rock or soft rock.
  - --Settings: Set lyric display as not displayed, display and backlight always display. And set play mode as looped play and random play.
- 
- Under the now playing list interface, press left soft key, then you can do operations as follows:
  - --Play: Play the MP3 you selected.
  - --add new MP3: Choose new MP3 from the T-card and add it to play list.
  - --Delete from play list: Delete the selected MP3 from play list.
  - --Save list: Save the current play list.

- --Clear current play; Clear all the MP3 in play list.

**Note: You can switch to next song by headset also**

## 6.5 Video player

- Enter the video play list interface, press left soft key, you could go on the following operations.
- --Play: play the video file.
- --Add Item: Choose new video from the T-card and add it to play list.
- --Update List: Update the play list.
- -- Delete from play list: Delete the selected video from play list.
- -- Details: View the details of the video, name, date, time, resolution ratio, time span, size and so on.
- --Set as Power on animation: Set the video as your power on animation.
- --Set as Power off animation set the video as your power off animation.
- --Mark: Choose the video or all the video files.

- **Note: The maximum resolution supported by this phone is 176X144 .**

## 6.6 FM Radio

You can listen to Fm radio freely. Enter the radio interface, search the frequency automatically by pressing the up and down direction keys, and change previous or next channel by pressing the left and right direction keys.

On the interface of the Radio playing, press left soft key you could enter the options menu and do operations as follows:

--Search automatically and save: Search frequency available automatically and save it to broadcasting station list.

--Broadcasting station: You can view all the broadcasting stations you saved.

--Save: Save the frequency you searched to the list.

--Manual input: Search the broadcasting station by input frequency manually.

--Background play: When the function is on, you can do other operations while listening to the radio.

**Note: When the battery of your cell is insufficient, you may not enter the Radio channel and you need to plug in the Stereo head set to listen the FM radio.**

**You can switch between Stations with Earphone.**

## 6.7 Sound Recorder

Use this function you can record or listen to your own Voice The record file format: wav.

- Press left soft key and select “record”. You can also do the following.
- — Start to record: Select “record” and continue the following steps;
  - — Records list: Select “records list”.

Enter “record” interface, move the cursor to the record icon and press OK key to record. During the process, press left soft key can make a pause, press it again will continue the record. Press right soft key can stop and save the record. You can press left soft key again and do the following.

Audition: Audition the tape you just recorded.

Delete: Delete the tape you just recorded.

Send: Send the tape to others via Bluetooth or .

Record File List: Enter the record file list to listen all recorded file.

## 7. Profiles

Six Profiles are available: Normal Mode, silent mode, meeting mode, indoor mode, outdoor mode. You can select any of these Profiles or customize your own profile by adjusting the parameters of the Profile. Restore to default settings by using the Restore option.

## 8. File Manager

You can check the specific content and service condition of the Memory Card via this function. You can also format the memory card.

Choose one folder and press left soft key, then you can operate as follows:

1. Create new folder: Create a new folder.
2. Delete: Delete the folder.
- 3 Details: Check details of the folder, name, date, size, position and so on.
4. Edit: Re-name or copy the folder.
5. Search: Search the file in the folder.
6. Sort: To sort according to name, date, size and type.
7. Mark: Mark one or all the folders in Memory Card.
8. Memory Enquiry: View the space in the memory. In this interface you can format the memory card by pressing left soft key, but this operation will cause the data in it lose forever.

## 9. Organizer

### 9.1 Alarm

You can edit alarm, time, ring and repeated ring mode.

You can select “alarm edit” mode, you can scroll up or down direction key, when the cursor goes to the desired option, press “OK”, then you can select desired settings.

### 9.2 Bluetooth

You can Activate/Deactivate Bluetooth.

--You can choose to “Activate” or “Deactivate” Bluetooth.

### **--Bluetooth Visibility:**

You can choose “visible” or “invisible” Bluetooth. If the Bluetooth is invisible, others cannot search your phone.

### **--Paired device:**

You can search different Bluetooth equipments and find compatible ones (as long as the PIN codes of two Bluetooth equipments are identical with each other, the match will be successful. The PIN code of Bluetooth earphone is different due to different type, and you can find the code in operating manual of the Bluetooth earphone.).

### **--Set sharing Files**

-- Directory Sharing Authority: You can choose “free access” or “read only”.

--Select directory: You can choose folder in the memory card as the storage position of received files by Bluetooth.

### **--My Bluetooth Name**

You can change the name of the phone.

### **--Help**

You can view the operating instruction of Bluetooth.

## **9.3 Calendar**

You can look up the calendar according to this function. Press left soft key on the Calendar interface, you can do the following.

### **--Calendar Schedule**

You can set up a calendar reminder.

### **--View Schedule**

You can check a calendar reminder of a certain date.

### **-- All Schedule**

You can check all calendar reminders.

### **--Clear Today's Calendar**

You can clear the calendar reminder of a certain date.

### **--Clear All**

You can clear all reminders.

### **--Go to Date**

You can check date.

### **--By Week**

Display weekly calendar reminder.

### **--Onscreen Prompts**

## **9.4 Calculator**

The function will make your device a calculator with which you can carry out simple math calculation.

## **9.5 World Clock**

The function will make your find the time and date and time in different city and country.



## **9.6 Torch**

To turn on/off the Torch.

## **9.7 Ebook**

The application is for you to read the.txt files stored in your phone or memory card.

## **9.7 Exchange Converter**

To get the conversion of currency.

## **9.8 Unit Conversion**

To get the conversion of Units.

### Technical Specification of W262

GSM Network	900/1800 MHz
Display Size	5.1 Cm
Battery Capacity	1800 mAh
Charger Specification	Input: 100-300V/50-60Hz Output : DC 5V /500mA
SAR Value	0.71 W/Kg
Camera Resolution	VGA Camera

# Warranty Card

## Welcome!

Congratulations on your new Wynncom Mobile Purchase.

## Limited Warranty:

Wynn Telecom Ltd. provides this Limited Warranty for your Mobile phone and original accessory delivered with your mobile Phone.

## Our Warranty:

Subject to the conditions of the limited Warranty, Wynn Telecom Ltd. warrant this product to be free from defects in design, material and workmanship at the time of its original purchase by a consumer, and for a subsequent period of:

- One (1) year for Transceiver
- Six (6) months for Charger, Battery, Headset and Data Cable

To get maximum use of your new product, we recommend you to:

- . Read the guideline for safe and efficient use in the user manual.
- . Keep your original receipt; you will need it for warranty repair claims.
- . Present this Warranty Certificate along with original proof of purchase having details of purchase & Serial No. whenever you require any warranty services.
- . Read the terms and conditions of your handset warranty in the user manual provided with the Product.

In the unlikely event if the product needs service, please visit the nearest Wynncom [Authorized Care Centre](#).

For more information on Wynncom Products and Services, please visit our Website: [www.wynncom.net](http://www.wynncom.net) or email us at: [customer.care@wynncom.net](mailto:customer.care@wynncom.net)

Or call at: 1800-102-9299 between 8 AM to 10 PM all days of the week.

Conditions Apply.